

















ALLE MATEN ZIJN CIRCA MATEN. HIER KUNNEN
GEEN RECHTEN AAN WORDEN VERLEEND



SITUATIE 1:500

RENVOOI INSTALLATIES

-  schakelaar t.b.v. lichtpunt
-  schakelaar t.b.v. buitenlichtpunt
-  wisselschakelaar t.b.v. lichtpunt
-  enkele wandcontactdoos met randaarde
-  dubbele wandcontactdoos met randaarde
- UTP**  bedrade leiding t.b.v. internet
- th**  thermostaat
-  loze leiding
-  plafond lichtpunt
-  wand lichtpunt
-  buiten wand lichtpunt
-  buiten lichtspot met schemerschakeling
- SS**  mechanisch afzuigpunt
-  toevoer mech. ventilatie
-  **RM** Rookmelder conform NEN 2555
-  deurbel
- *VV** vloerverwarming

Voorstraat 48
3311 ER Dordrecht
www.stijlarchitectuur.nl

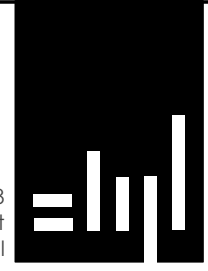

STIJL ARCHITECTUUR

T. 078-648 96 07
F. 078-648 96 08
info@stijlarchitectuur.nl

OPDRACHTGEVER

**BIK Bouw
Barendrecht**

WERK

**Dyckstede
Barendrecht**

FORMAAT

A3

SCHAAL

1:100 - 1:50

TEKENINGDATUM

25-11-2022

WIJZIGINGSDATUM

a 03-04-2023	c	e	g
b 04-05-2023	d	f	h

BESTEKNUMMER

019-665

BLADNUMMER

VK-11

ONDERDEEL

**VERKOOPTEKENING
BOUWNUMMER 11**

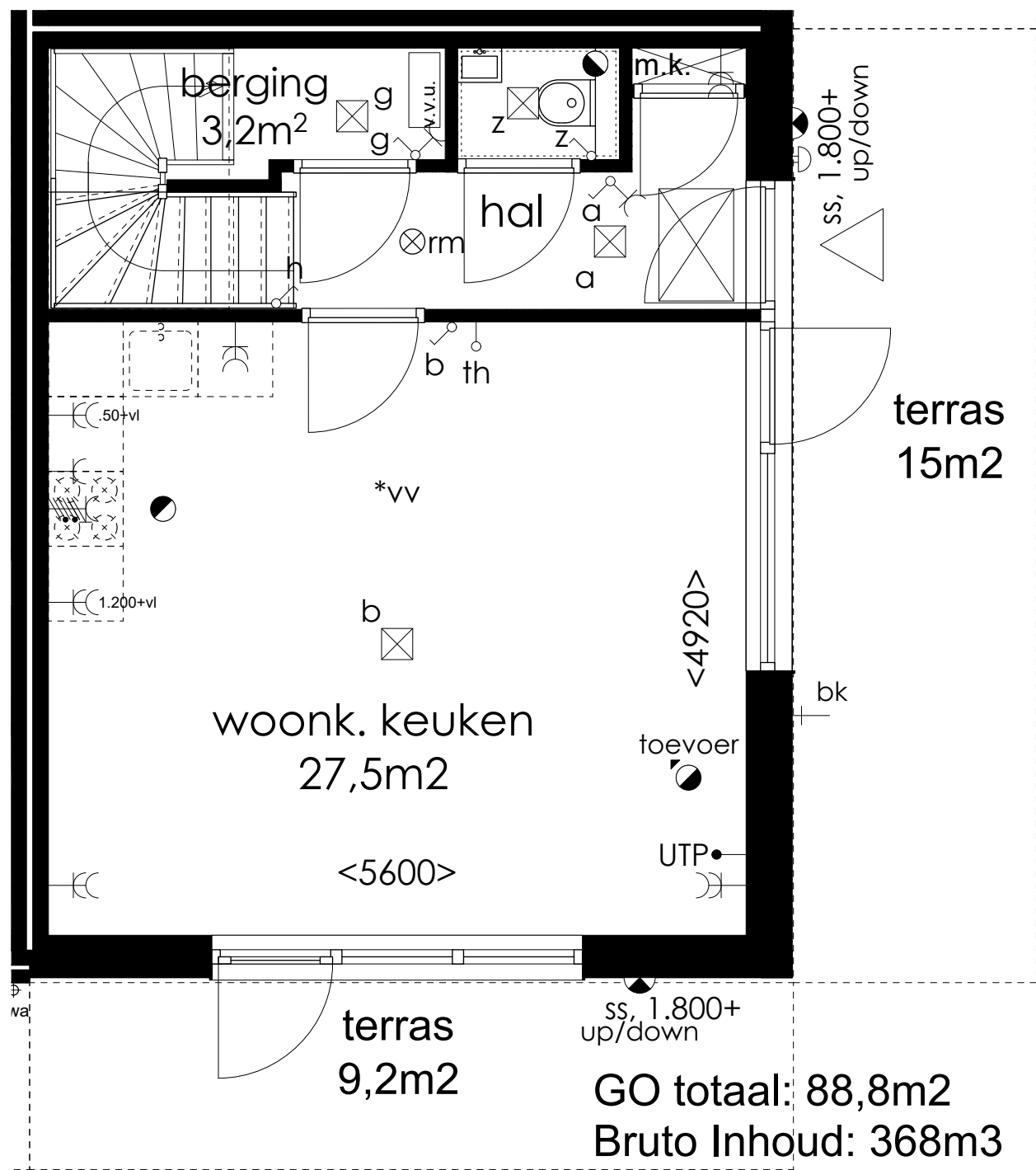

BEGANE GROND

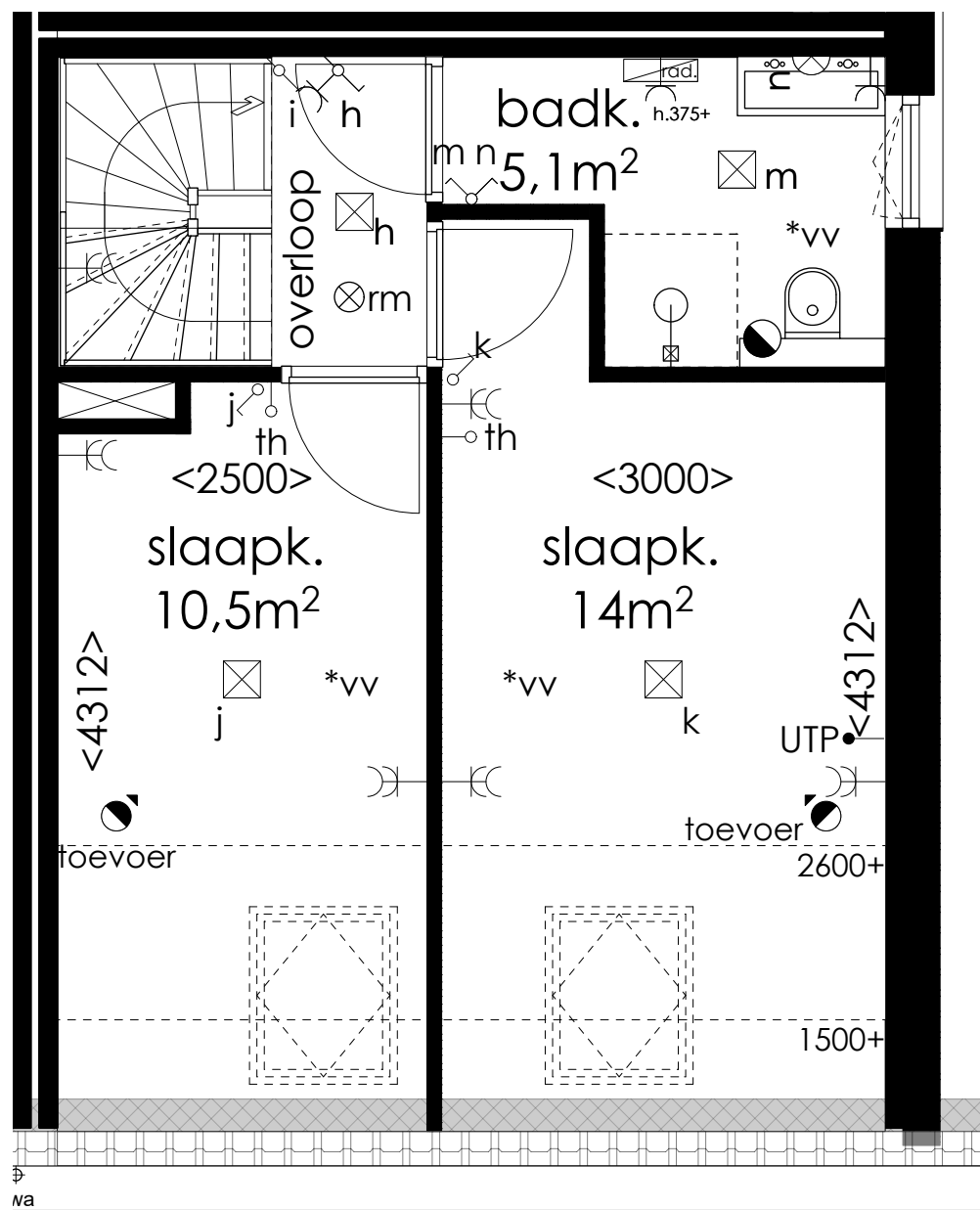

VERDIEPING

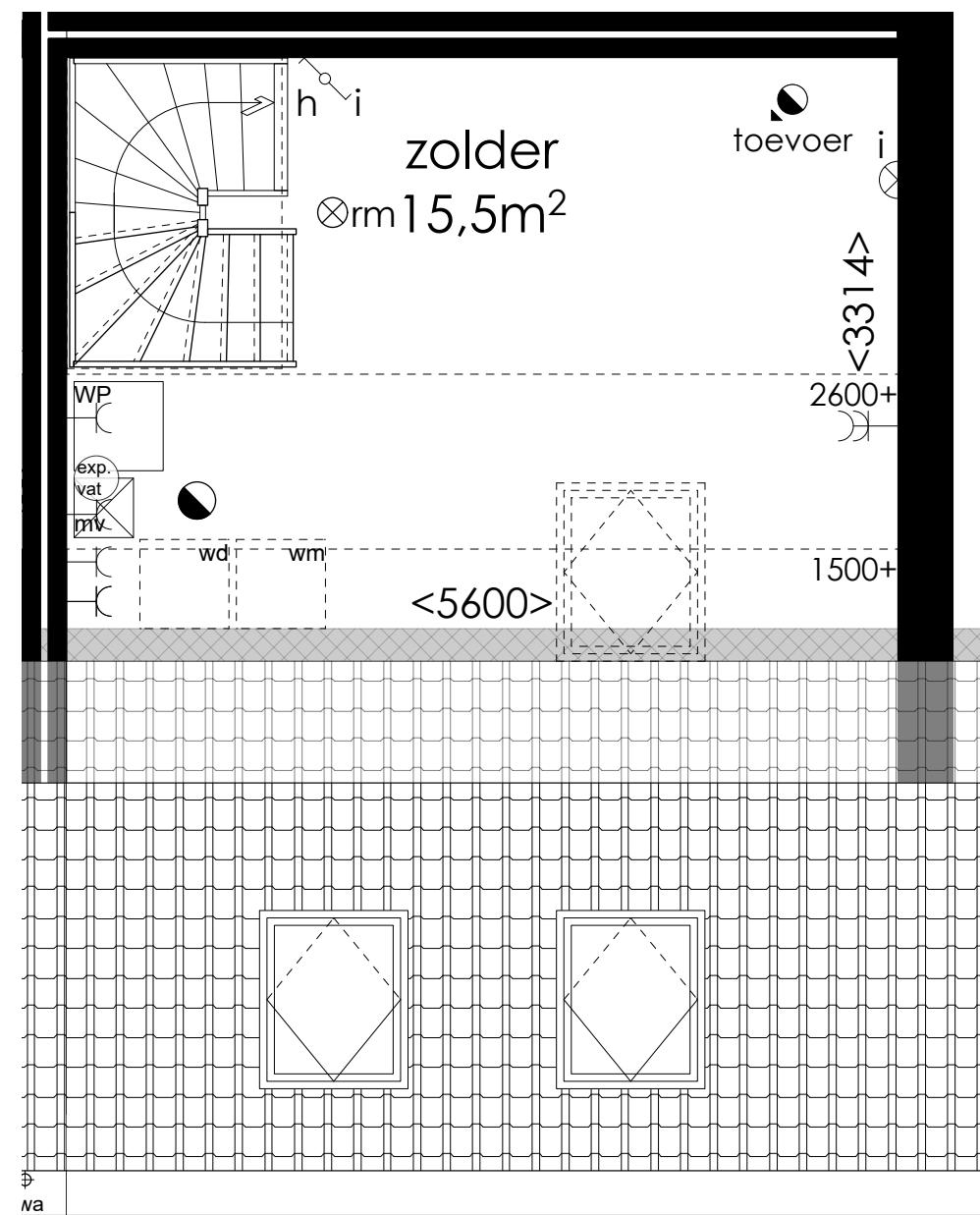

ZOLDER

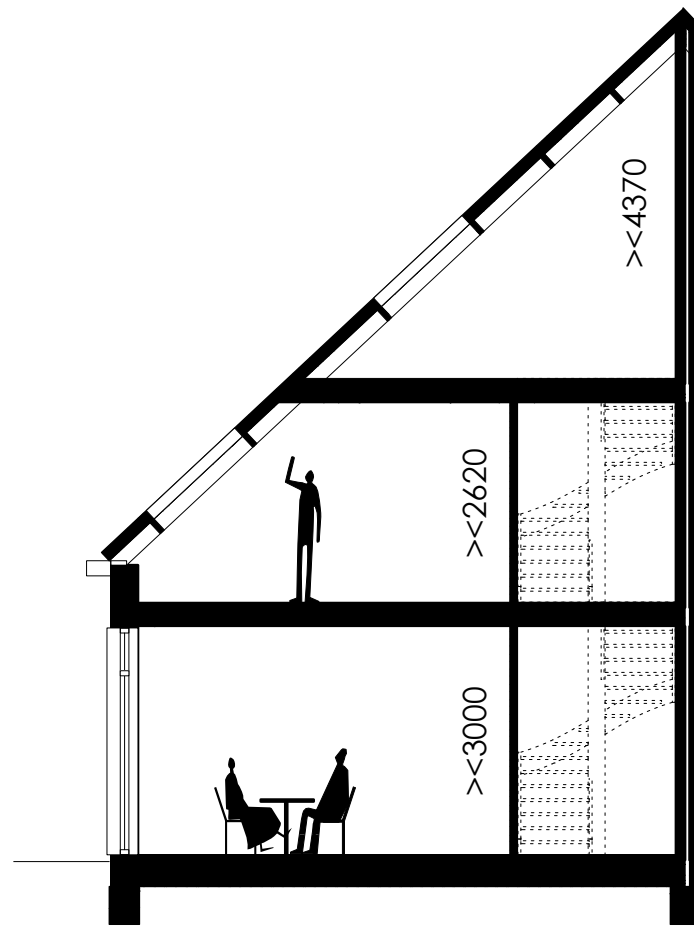

DOORSNEDE



VOORGEVEL

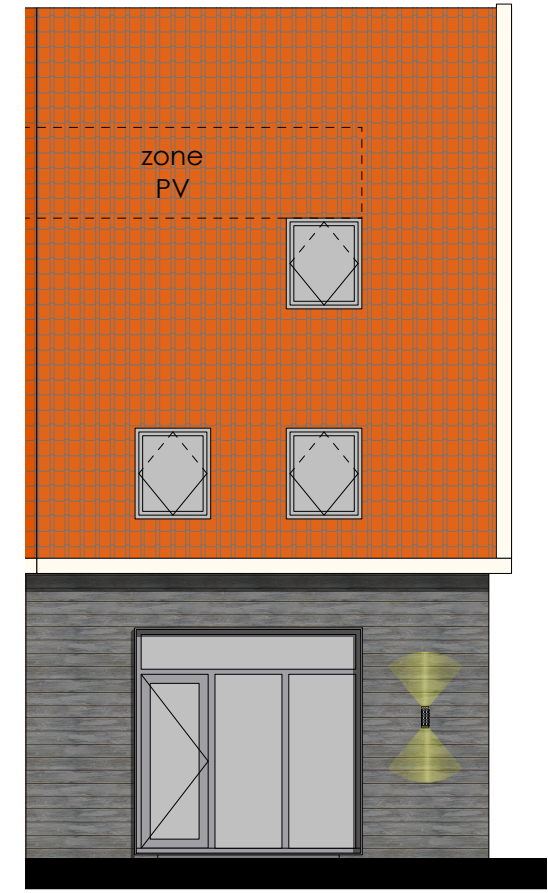

















LINKER ZIJGEVEL

ALLE MATEN ZIJN CIRCA MATEN. HIER KUNNEN
GEEN RECHTEN AAN WORDEN VERLEEND



SITUATIE 1:500

RENVOOI INSTALLATIES

-  schakelaar t.b.v. lichtpunt
-  schakelaar t.b.v. buitenlichtpunt
-  wisselschakelaar t.b.v. lichtpunt
-  enkele wandcontactdoos met randaarde
-  dubbele wandcontactdoos met randaarde
- UTP**  bedrade leiding t.b.v. internet
- th**  thermostaat
-  loze leiding
-  plafond lichtpunt
-  wand lichtpunt
-  buiten wand lichtpunt
-  buiten lichtspot met schemerschakeling
- SS**  mechanisch afzuigpunt
-  toevoer mech. ventilatie
-  **RM** Rookmelder conform NEN 2555
-  deurbel
- *VV**  vloerverwarming

Voorstraat 48
3311 ER Dordrecht
www.stijlarchitectuur.nl

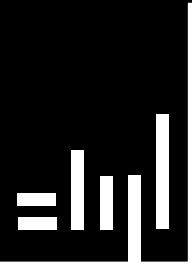

STIJL ARCHITECTUUR

T. 078-648 96 07
F. 078-648 96 08
info@stijlarchitectuur.nl

OPDRACHTGEVER

**BIK Bouw
Barendrecht**

WERK

**Dyckstede
Barendrecht**

FORMAAT

A3

SCHAAL

1:100 - 1:50

TEKENINGDATUM

25-11-2022

WIJZIGINGSDATUM

a 03-04-2023	c	e	g
b 04-05-2023	d	f	h

BESTEKNUMMER

019-665

BLADNUMMER

VK-12

ONDERDEEL

**VERKOOPTEKENING
BOUWNUMMER 12**

GO totaal: 80,5m²
Bruto Inhoud: 368m³



BEGANE GROND

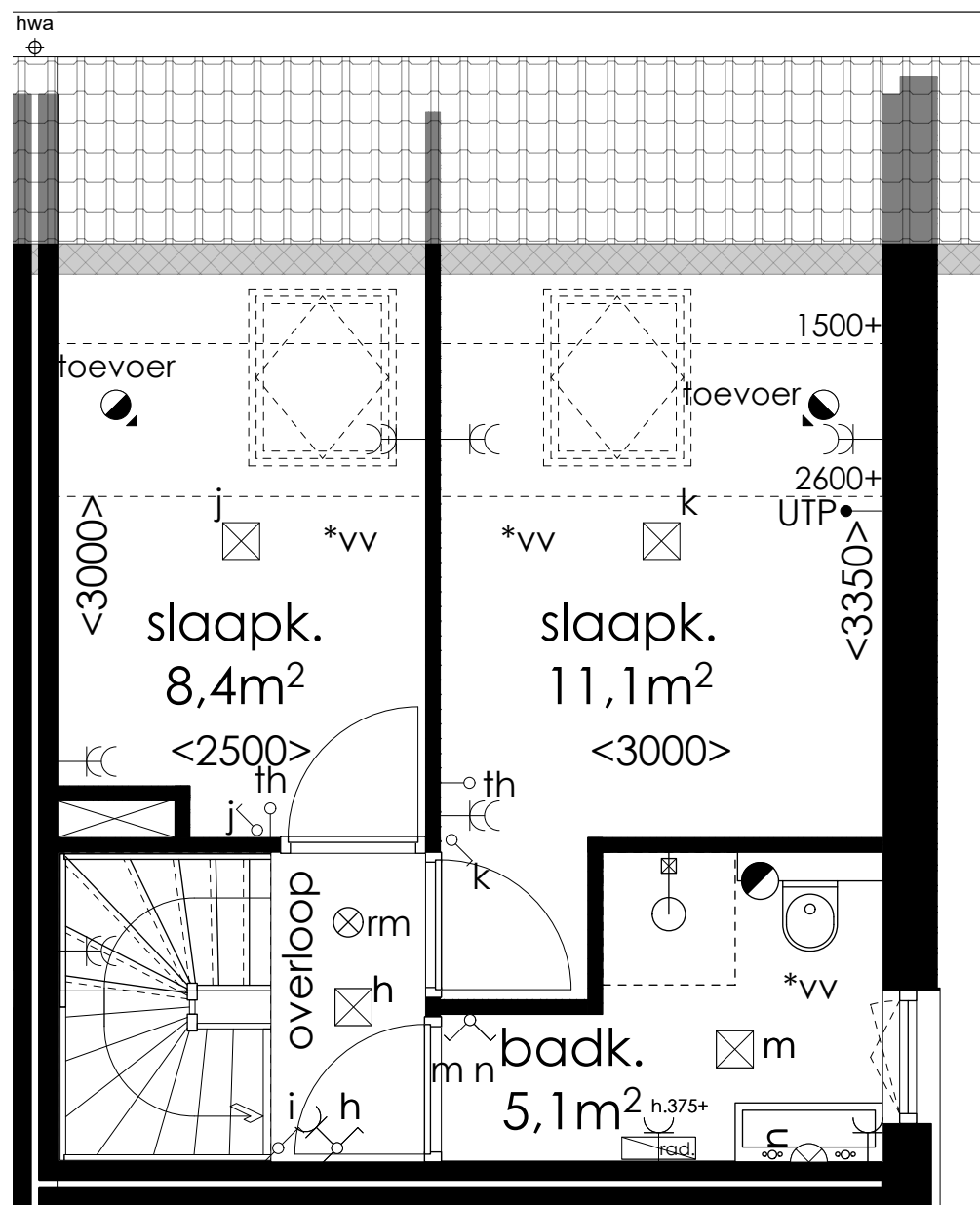

VERDIEPING

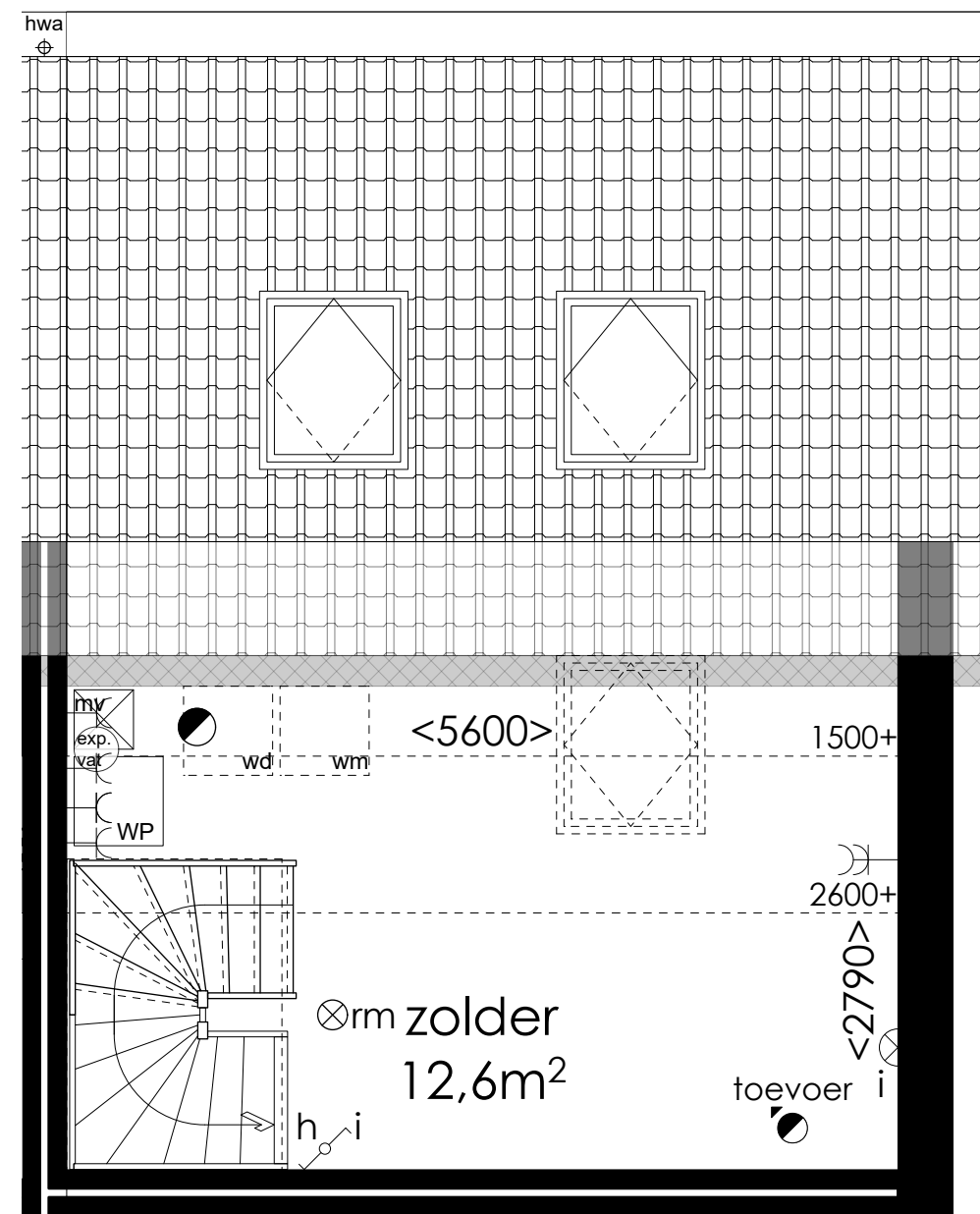

ZOLDER

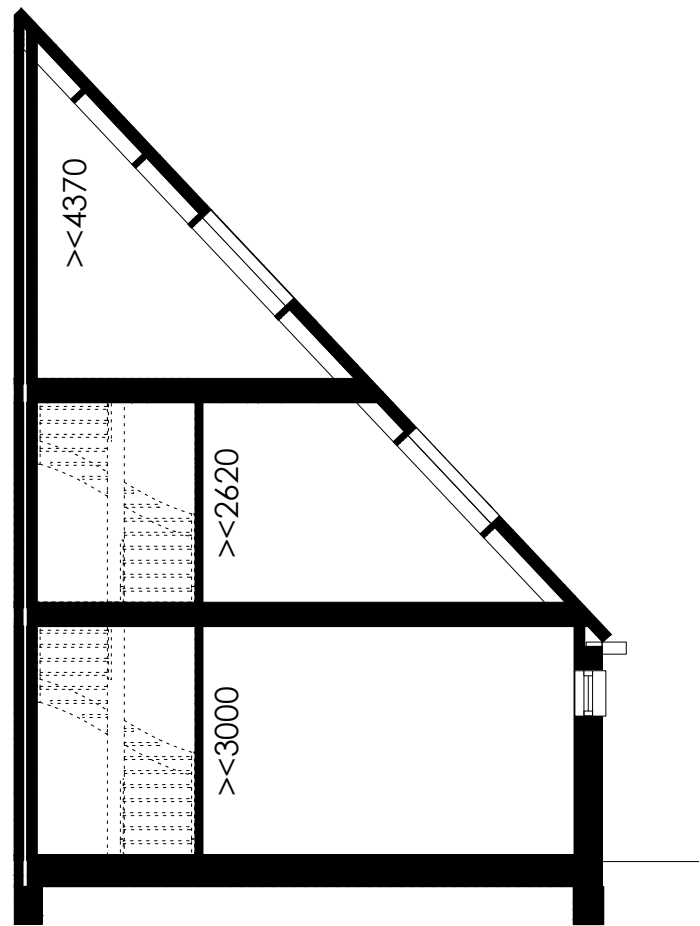

DOORSNEDE



VOORGEVEL

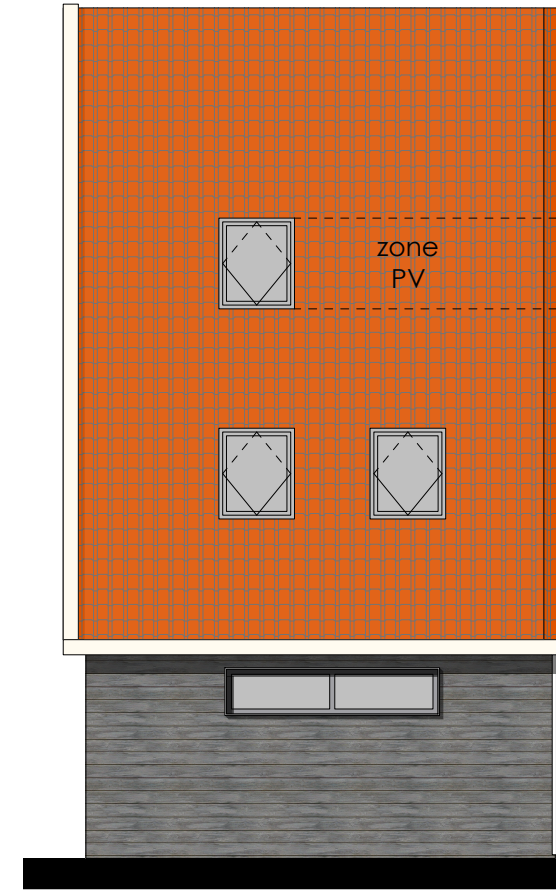

RECHTER ZIJGEVEL